

B36-9W

TECHNICAL SPECIFICATIONS

- Sizes: 3/4" x 36" x 1/2" H
- Colours: Aluminum and white plastic lens
- DC12V / DEL 9 WATTS
- 879 LUMENS
- CRI: > 85
- Rail: 36"
- Must be installed with a Lumifaro driver

LIGHT BAR DIMENSIONS

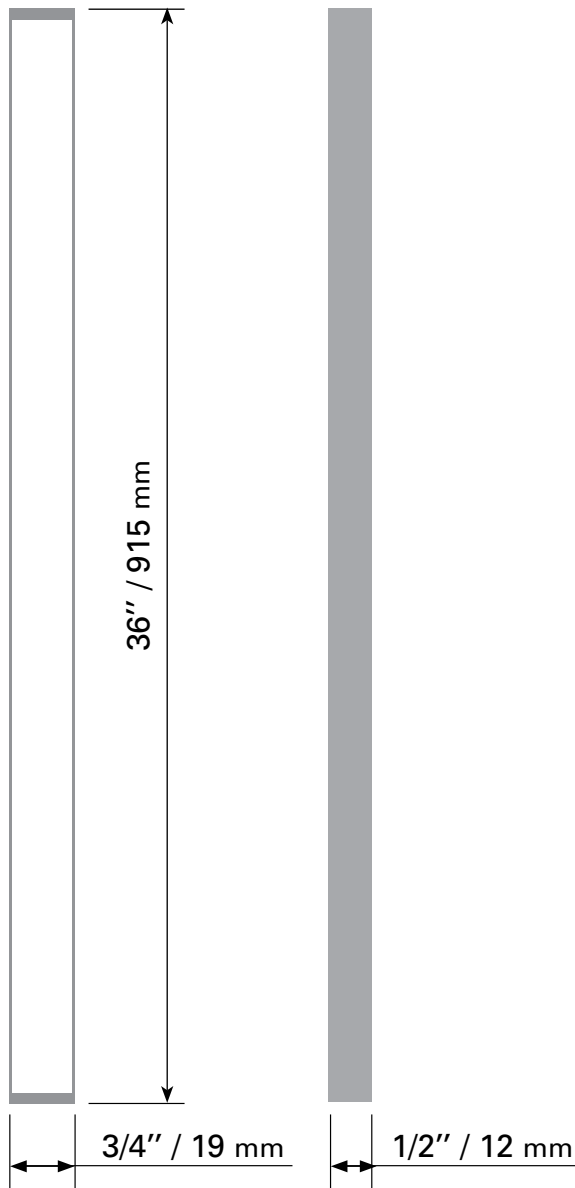

4300 Grande-Allée Blvd, Boisbriand
QC, Canada J7H 1M9

450 979-0667
info@lumifaro.com
www.lumifaro.com

CLIENT:
PROJECT:
DATE:

EASY INSTALLATION

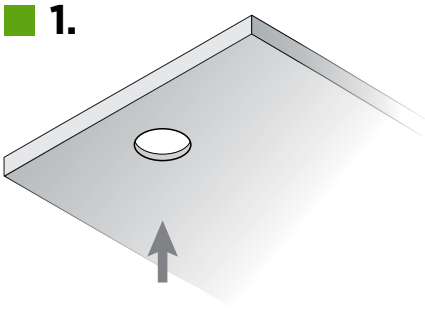

Determine the location for installation and cut a hole on the bottom of cabinet with dimension $\varnothing 1"$.

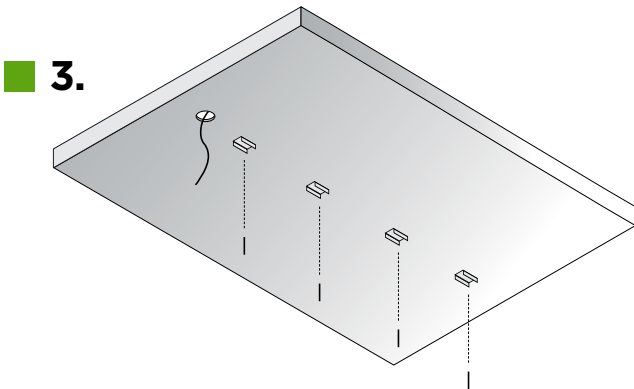

Install the stain steel clips with the little screws to the bottom of the cabinet. It needs 2 clips to hold each light bar and make sure they are on the straight line.

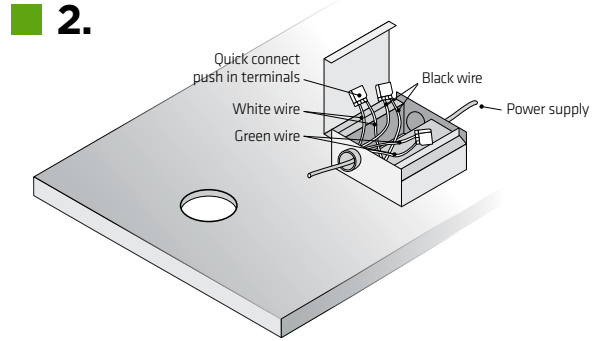

Put the junction box in the cabinet. The most important thing is to make sure it is CLASS II power and the output voltage is DC12V. Open the junction box cover and remove the appropriate knockout(s) on the side panel. Insert the electrical supply cable through the knockout and secure with a cable connector (sold separately). Using quick-connect push-in terminals, connect the ground wire to the green wire terminal, black wire to black wire terminal, white wire to white wire terminal.

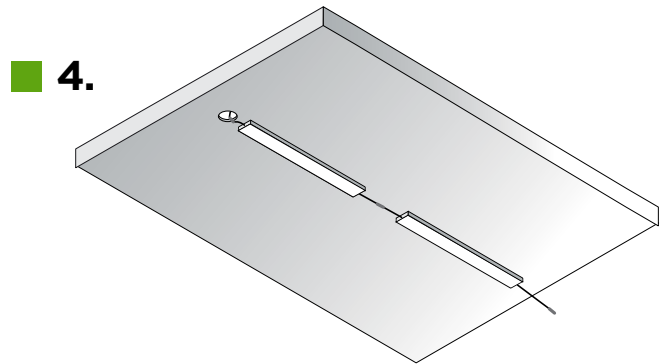

Connect the first light bar to the connector from the junction box. Then connect the other light bars to the previous light bar one by one. The max wattage showed as below.

WATTAGE OF DRIVER	MAX WATTAGE OF LIGHT BARS
12W	9W
24W	19W
36W	29W
48W	38W
60W	48W

CAUTION: ALWAYS CLOSE ELECTRICAL CURRENT BEFORE CONNECTING A LED DEVICE, otherwise the driver will be affected.

IMPORTANT: NEVER attempt any work without shutting off the electricity.

- Read all instructions before installing.
- System is intended for installation by a qualified electrician in accordance with the National Electrical Code and local regulations.
- Go to the main fuse box, or circuit breaker. Place the main power switch in the "OFF" position and unscrew the fuse(s) or switch "OFF" the circuit breaker switch(es) that control the power to the fixture or room that you are working on.
- Place the wall switch in the "OFF" position.
- Supply conductors (Power Wires) Connecting the fixture must be rated minimum 90°C. If uncertain, consult an electrician.

CAUTIONS

- These luminaires (fixtures) are designed to meet the cETLus requirements.
- Before installation, please check your local electrical code, as it sets the wiring standards for your locality.